

STANLEY®

2018 SECURITY CATALOG

Your world. Truly secure.



ONE DAY WITH STANLEY LOCKS

BIKE LOCK

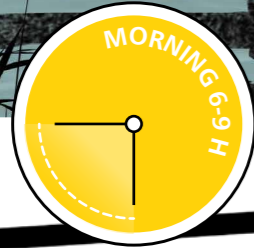
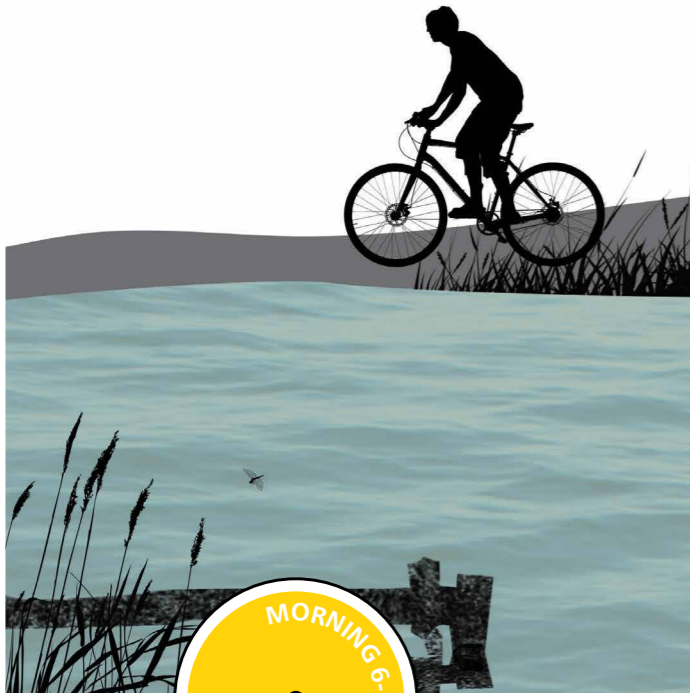

INDOOR COMBINATION LOCK

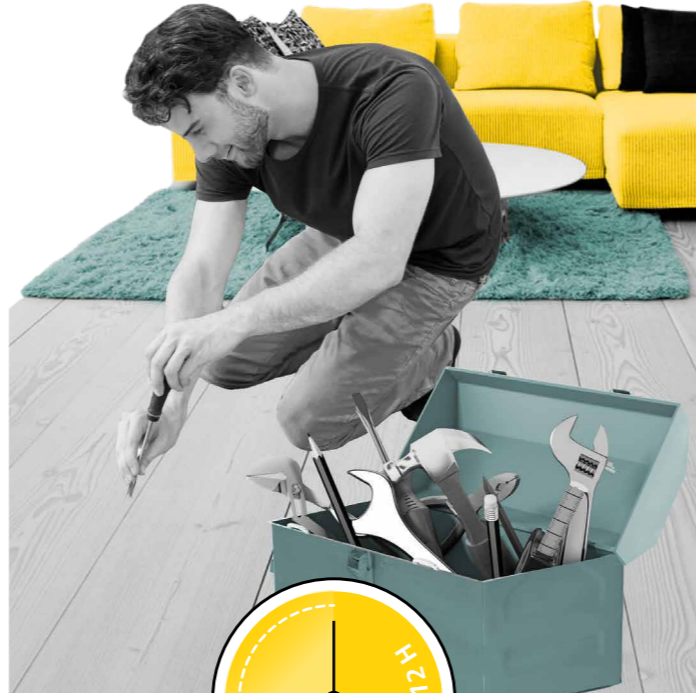

INDOOR COMBINATION LOCK

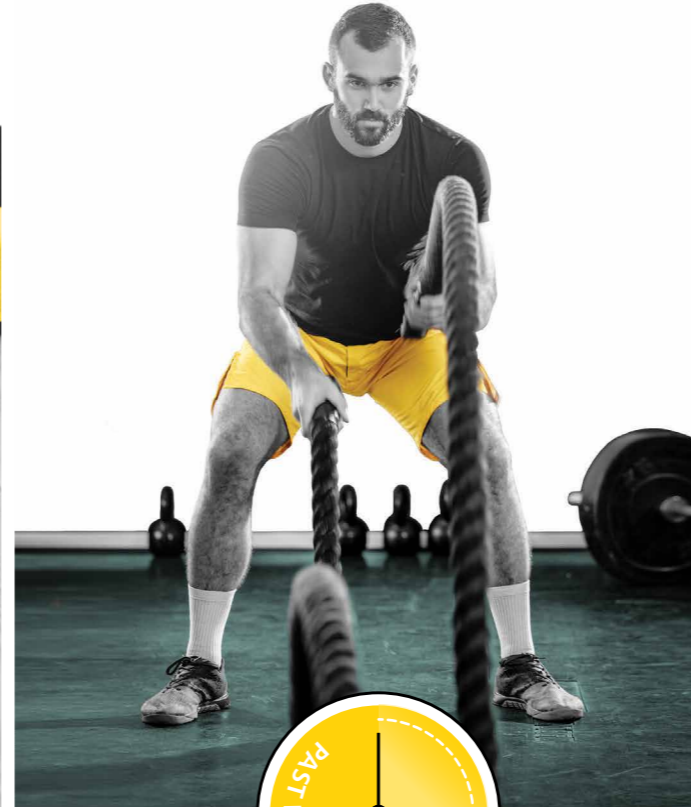

LOVE LOCK



SINGLES & FAMILIES USES STANLEY LOCKS

SINGLES & FAMILIES USES STANLEY LOCKS



LUGGAGE TSA LOCKS



CARABINER LOCK



SOLID BRASS ARMORED



FAMILY BIKE LOCK

STANLEY®

ONE MAN, ONE VISION, 170 YEARS OF SUCCESS

In 1843, Frederick T. Stanley founded "The Stanley Works" – a small company that manufactured hinges, bolts and other door hardware in New Britain, Connecticut. His vision was to offer products that would become the first choice among professionals around the world.

Thanks to the increasing demand for his high-quality products, Mr. Stanley began exporting in the 1870s. Soon his rapidly growing business established its first production facilities outside the U.S. By 1920, STANLEY brand hardware was preferred, and could be found on every continent.

Today STANLEY is one of the world's most recognized and trusted brand names for hardware products. Providing outstanding quality and maximum security, STANLEY has gained an excellent reputation as an expert for padlocks. You can count on STANLEY as a strong retail partner just as you can count on its successful products presented in the following.

2017



Stanley is a truly global brand.



In addition to creating outstanding products, the company also sponsors major global sports leagues like English Premier League, Moto GP and others. Stanley even has partnerships with major brands like Disney and FC Barcelona.

1969



Stanley went to the moon in 1969

1900 1890 1870

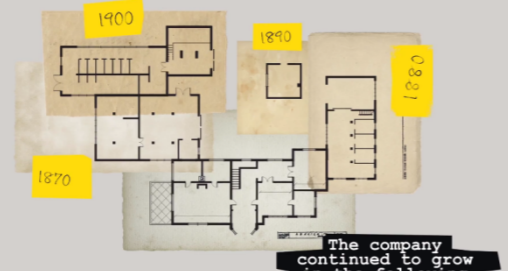

The company continued to grow in the following decades.

YEAR 1854

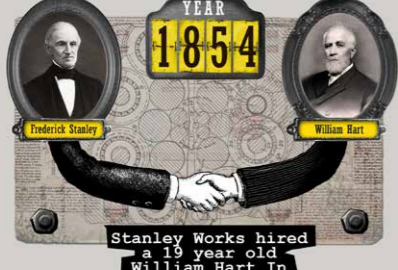

Stanley Works hired a 19 year old William Hart in 1854.

1963



During 1963, Stanley finished building the largest hand tool plant in the world in New Britain...

NEW BRITAIN CONNECTICUT



Frederick Stanley founded a small shop in New Britain, Connecticut.

1843

YEAR 1852



into forging other types of hardware. He names his business Stanley Works.

THREE PADLOCK RANGES AND BIKE LOCKS OFFERED BY STANLEY

Professional Security 24/7 premium padlocks offer our highest level of security

- ✓ ideal for professionals and heavy user who expect maximum security
- ✓ reliable even under harshest conditions
- ✓ high-quality materials and special features respond to highest demands and ensure your sales success

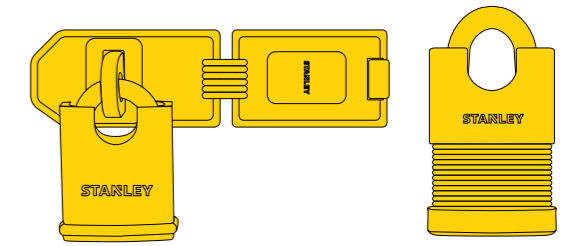

Reliable padlocks for every day-use

INDOOR OUTDOOR ALL-WEATHER

- ✓ meet all demands of the mass market and drive your sales and profit
- ✓ cover all relevant price points
- ✓ always providing the security and quality of a branded product

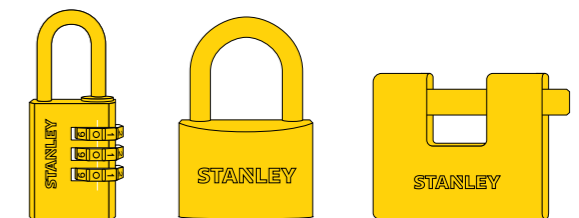

TRAVELMAX™

A must-have product for travelers

- ✓ drive additional sales
- ✓ available in different types
- ✓ various attractive colors and finishes



TSA: the international standard for Travel Security. Travel Sentry Approved (TSA) locks can be opened and re-locked with a special key by international security administration at every airport.



Special locks

- ✓ offer special promotional padlocks
- ✓ drive additional sales
- ✓ Love Lock for emotional moments
- ✓ Carabiner Lock incl. 180cm leash in 2 different styles

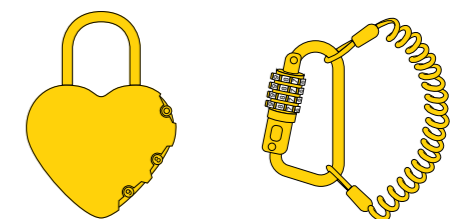

Bike locks for mobile safety

HIGH MEDIUM STANDARD

- ✓ wide range of convenient & reliable Bike Locks
- ✓ U-Shape, Cable Key, Cable Combination & Reflective
- ✓ solutions for quick stop or an all-day lock-up

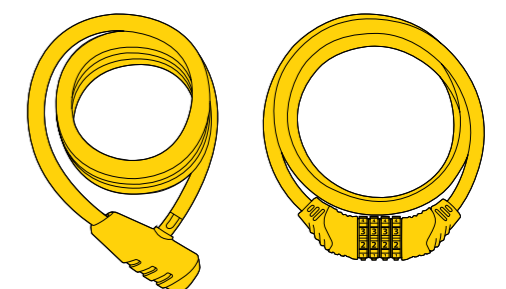

COLOR CONCEPT –

STANLEY

- ✓ For different application areas
- ✓ Better orientation
- ✓ Quick purchase decision



**ALL-WEATHER
Padlocks**

The Stanley® All Weather Padlocks with the blue label offer additional protection against corrosion near coastal environments by using exterior chrome plating. Perfect for use with boats and boat trailers.



**OUTDOOR
Padlocks**

The Stanley® Outdoor Brass Padlocks are the all-around padlocks for nearly every outdoor use: constructed with brass pins, stainless steel springs and a double locking hardened steel shackle, these padlocks are perfect for securing fences, sheds, containers or chains.



**SPECIAL
Padlocks**

Stanley® offers a variety of specialty locks like a Love Lock to show your love in a unique way or a Carabiner lock with a leash to secure your belongings while you are on the go.



**HIGH SECURITY
Bike locks**

Stanley® High Security Bike Locks are ideal for all-day & overnight lock-ups in suburban and metropolitan areas when locking valuable bikes and scooters.



**INDOOR
Padlocks**

The green-labeled Stanley® Indoor Combination Padlocks are made with a high quality solid brass cage and wheels designed to provide basic protection for indoor applications like lockers or tool boxes.



**TRAVELMAX™
Padlocks**

The Stanley® TSA Padlocks are the perfect companion for travelers around the world. Travel Sentry Approved (TSA) padlocks can be opened and re-locked with a special key by the international security administration at every airport worldwide without destruction, and can even show you if your luggage was screened. They are available in different colors, surfaces, and shapes to personalize your baggage.



**MEDIUM SECURITY
Bike locks**

Medium Security Bike Locks with a flexible steel cable are made for locking bikes in suburban and public areas for a few hours or all-day long. Available in combination and keyed versions.



**STANDARD SECURITY
Bike locks**

Standard security bike locks are ideal for quick stops and hourly lock-ups. Available in combination and keyed versions.

COLOR CONCEPT – for a better orientation at POS



Placement Layout

Clear structure for the padlock shelf – shelf layout is created according to the decision making process of the consumer.

Clear color coding for the padlocks for luggage, indoor, outdoor, and areas with high humidity and salt water. (from left to right: grey, green, red and blue).

Within each color the different padlock sizes are arranged from left to right from smaller sizes to bigger sizes – the long shackle version of each corresponding padlock type and size is always placed below the standard shackle size to allow a full view on all options for the consumer.

The Stanley category management approach implies that high valuable & focus products are placed more at the mid & right sides which attract most attention of the consumer.

The quantity of hooks of the assortment & different product types is chosen based on customer sales figures and internal rankings.

Each layout is created individually for our customers.

Please keep in mind: the shelf structure and layout depend on individual outlets / sales channels and shelf layouts as well as available shelf space. It also has to be adjusted to existing competitor assortments and needs adaptations in case of changed settings in the outlet.

POS SUPPORT – for driving your sales

	Floor Display*	Counter Display*	Counter Display*	Side Rail*
VKB	89026 202 015	89026 100 009	89017 100 004	89026 172 004
Hooks	15	6	4	4
Hook Length	20 cm	20 cm	12 cm	12 cm
Base	39 x 39 cm	38 x 26 cm	28,5 cm x 15,5 cm	8 x 3 cm
Height	163,1 cm	64 cm	47 cm	73 cm

*Displays without garnishing

	Floor Display Large	Floor Display Tray	Counter Stand
VKB	Available on request	Available on request	Available on request
Facings	Hook Solution	10 facings	4 facings
Garnishing	Empty display version	Empty display version	Empty display version
Base	60 x 40 cm	60 x 40 cm	25 x 45 cm
Height	187 cm incl. Crowner	129 cm incl. Crowner	20 cm incl. Crowner

POS SUPPORT – for driving your sales

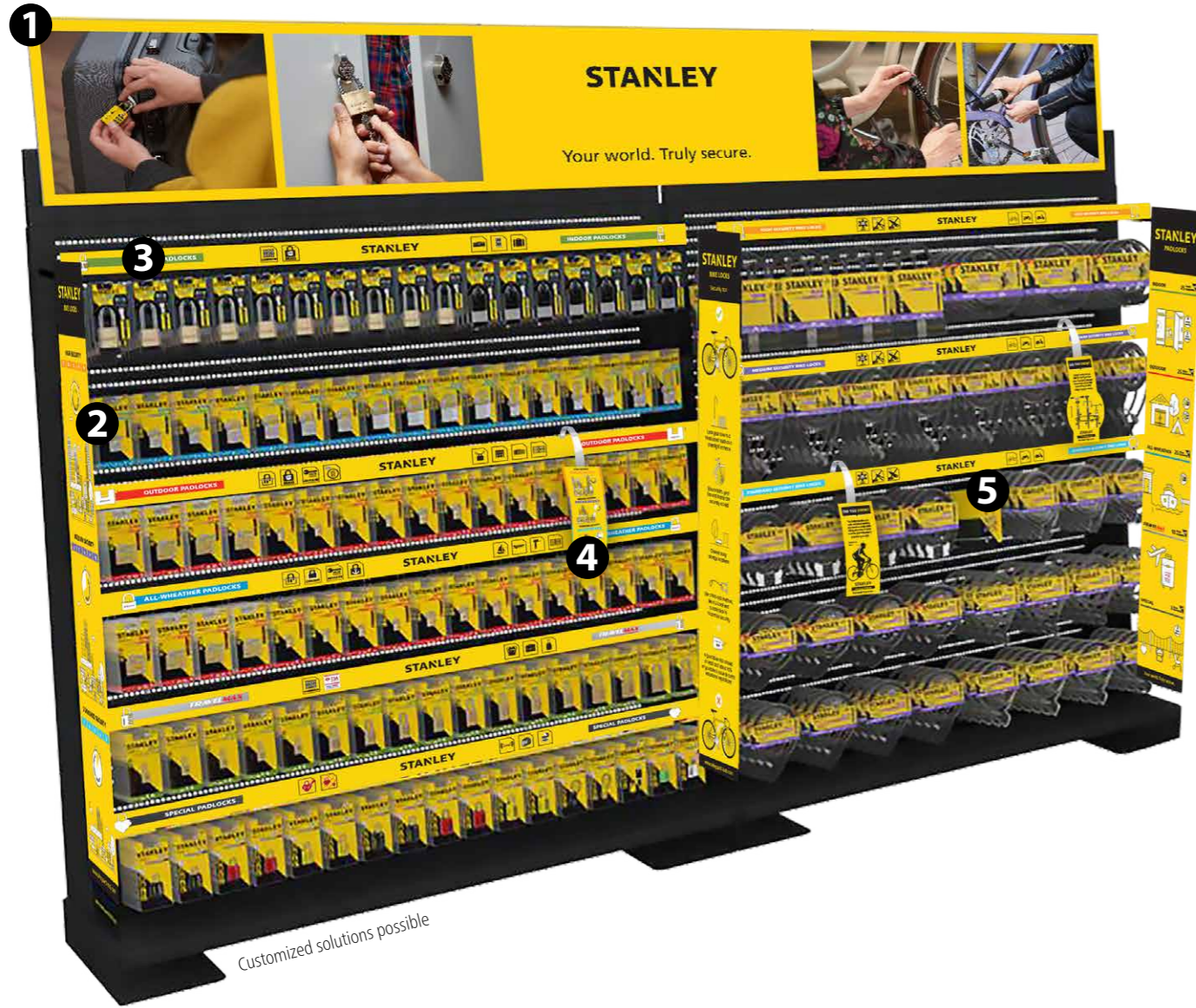

1 HEADER



STANLEY

Your world. Truly secure.

Dimensions: 1330 x 600 mm
4/4 coloured Dispersion varnish



2 SHELF STOPPERS

Dimensions: 140 x 850 mm
Coated paper 350g/qm
4/4 coloured, dispersion varnish

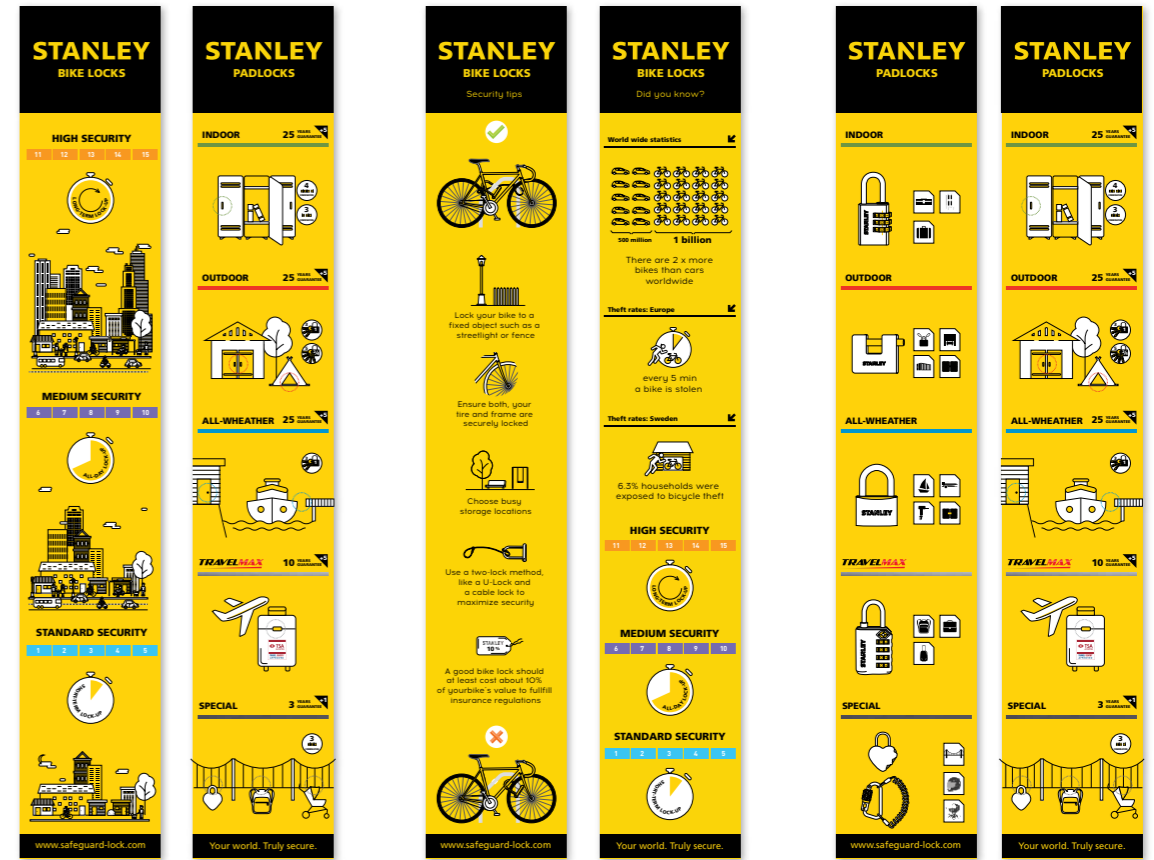

3 SHELF RAILS



4 WOBBLERS



5 BROCHURE



DISPLAYS

TSA DISPLAYS - READY TO SELL



R2S	TSA metal rail	TSA Mix Counter	Whiteboard Promo TSA Counter
VKB	87040 112 801	86340 112 811	86340 112 801
Facings	4	4	4
Hook Length	20 cm	—	—
Garnishing	4 x 81140 393 401, 4 x 81142 393 401 4 x 81160 393 401, 4 x 81161 393 401 In Total: 16 Blister	16 x S742-054 3 Digit 30mm black Indicator 8 x S742-055 3 Digit 30mm red Indicator 8 x S742-061 3 Digit 20mm vinyl yellow Total: 32 blister	32 x S888-001 Whiteboard Promo TSA
Base	8 x 3 cm	45 x 28 cm	45 x 28 cm
Height	73 cm	20 cm (excl. crowner)	20 cm (excl. crowner)

STANLEY SPECIAL DISPLAYS



R2S	Mixed TSA Floor Display	Love Lock Floor Display
VKB	88140 112 801	81150112 801
Facings	10	10
Garnishing	12x S742-054 Indicator black 6x S742-056 Indicator yellow 10x S742-061 Vinyl yellow 10x S741-165 Whiteboard 6x S742-055 Indicator red 10x S742-060 Vinyl black Total: 54 blister	in 2 facings in 1 facing in 2 facings in 2 facings in 1 facing in 2 facings
Base	60cm x 40 cm	60cm x 40 cm
Height	129 cm incl. Crowner	129 cm incl. Crowner

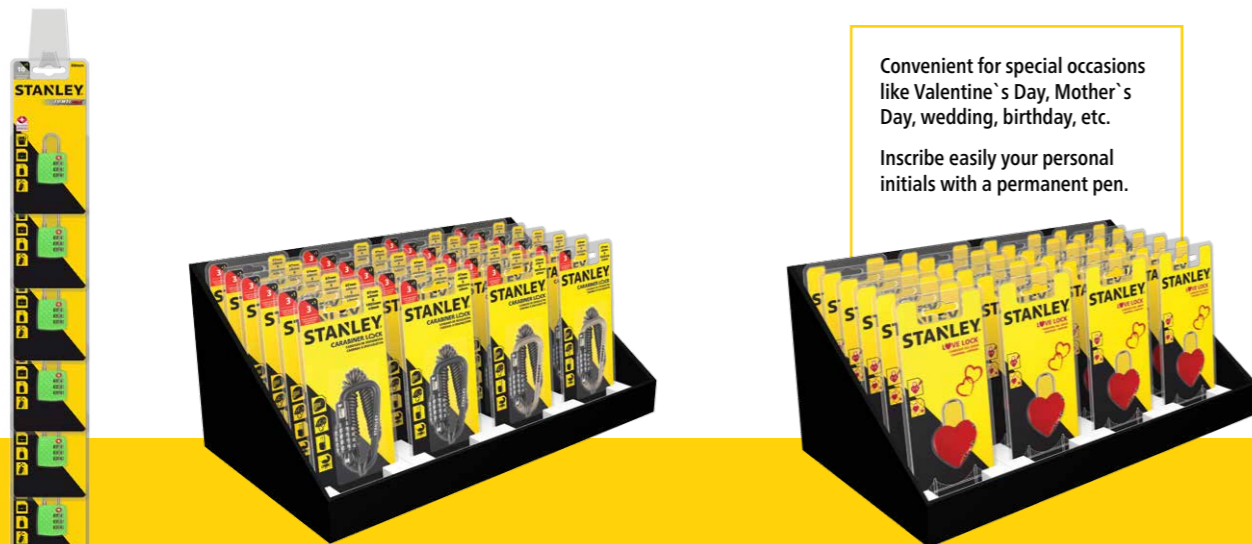

Convenient for special occasions like Valentine's Day, Mother's Day, wedding, birthday, etc.
Inscribe easily your personal initials with a permanent pen.

R2S	Clip strip	Carabiner Counter	Love Lock Counter
VKB	87340 112 801	86369 112 801	86350 112 801
Facings	10	4	4
Hook Length	—	—	—
Garnishing	10 Blister per Clipstrip 2 Clipstrip per Carton	16 x S744-030 Carabiner black in 2 facings 16 x S744-031 Carabiner silver in 2 facings Total: 32 blister	32 x S742-065 Love Lock
Base	—	45 x 28 cm	45 x 28 cm
Height	100 cm	20 cm (excl. crowner)	20 cm (excl. crowner)



R2S	P60 bike lock floor display
VKB	88069 112 801
Hooks	14
Hook Length	20 cm
Garnishing	3 Hooks à 3 pieces 81310 385 111 3 Hooks à 3 pieces 81320 385 111 2 Hooks à 5 pieces 81311 385 111 2 Hooks à 5 pieces 81321 385 111 4 Hooks à 3 pieces 81301 385 111 In Total: 50 Blister
Base	60 x 40 cm
Height	187 cm

STANLEY. PADLOCKS



24/7 LAMINATED PADLOCKS

STANLEY PROFESSIONAL SECURITY 24/7

ALL-WEATHER

The Stanley® Professional Security 24/7 Laminated padlock is constructed with a heavy duty laminated steel body, hardened steel end caps and recessed rivets which brings maximum protection to the job site. Stanley also carries laminated padlocks with a shrouded body, providing even greater resistance to pry attacks.

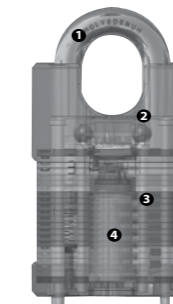

Premium Shrouded Padlock

- ❶ Cut Resistant Steel Shackle Protects Against Sawing And Cutting Attacks.
- ❷ Dual Ball-Bearing Locking System Resists Pry Attacks.
- ❸ Six-Pin Rekeyable Solid Brass Cylinder With Anti-Pick Pin That Resists Picking Attacks.
- ❹ Patented Keyway Cover Protects Against Drilling Attacks.

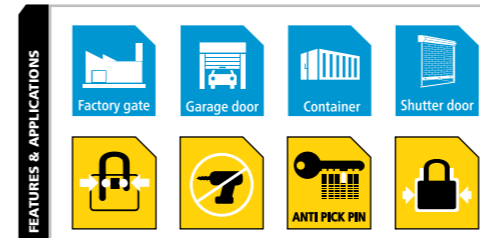

Laminated Security Lock

- Laminated 50mm std. Shackle shrouded
- Laminated 50mm std. Shackle
- 2 Laminated 50mm std. Shackle
- Laminated 60mm long Shackle

For more details please see page 34

24/7 SOLID BRASS PADLOCKS

STANLEY PROFESSIONAL SECURITY 24/7

ALL-WEATHER

The Stanley® Professional Security 24/7 Solid Brass padlock features a solid brass body that protects it from corrosion and a molded rubber cover to protect the keyway in extreme weather environments. In addition, it has all the maximum security features your application demands.



All-Weather Solid Brass Security Lock

- ❶ Cut Resistant Steel Shackle Protects Against Sawing And Cutting Attacks.
- ❷ Dual Ball-Bearing Locking System Resists Pry Attacks.
- ❸ Six-Pin Rekeyable Solid Brass Cylinder With Anti-Pick Pin That Resists Picking Attacks.
- ❹ Bottom Cover Seals Lock From The Elements.

Solid Brass Security Lock

- Solid Brass 50mm std. Shackle
- Solid Brass 50mm long Shackle

For more details please see page 34

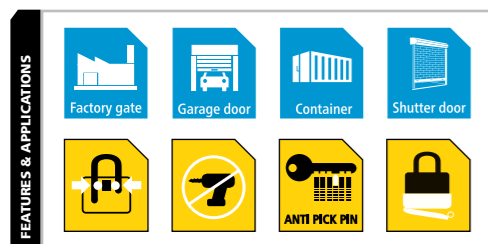

24/7 SHROUDED PADLOCK + HASP

STANLEY PROFESSIONAL SECURITY 24/7

ALL-WEATHER

The Premium Shrouded Padlock is perfect for both professional and private use security needs. The hardened shackle provides a maximum cut and pry protection. Additionally for strength and corrosion protection the padlock consists of a solid brass body. In combination with the Heavy-Duty Security Hasp this padlock is suitable for outdoor use, for example garden fences or garage doors.

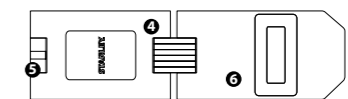
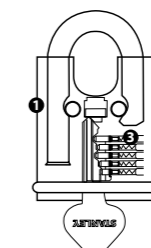

Premium Shrouded Padlock

- ❶ Solid Brass Body For Strength And Corrosion Protection.
- ❷ Plastic Bumper Protects Surfaces From Scratching.
- ❸ 5 Pin Cylinder For Added Pick Resistance.
- ❹ Hardened Steel Construction For Added Security.
- ❺ Anti-Pullout Riveted Hinge.
- ❻ Duplex Nickel Plating For Protection In The Harshesht environments.

Premium Shrouded Padlock with Heavy Duty Security Hasp

- 50mm Shrouded Padlock + Hasp

For more details please see page 35

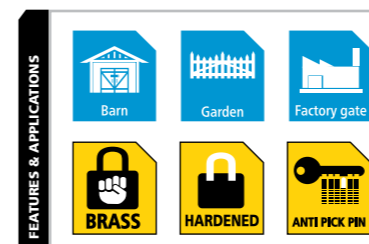

PRODUCTS

SOLID BRASS CHROME PLATED

ALL-WEATHER

25 +5
*25 years guarantee
25 años de garantía
Garantie 25 ans



The Stanley® Marine Padlocks offer additional protection against corrosion near coastal environments. Utilizing the same features found on our Brass padlocks, the Marine line of padlocks features an exterior chrome plating that makes them an ideal choice for securing property in outdoor applications. Available in standard or long shackle.

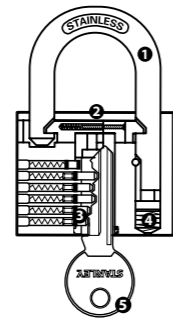

Standard Shackle Padlock

- 1 Double Locking Hardened Steel Shackle.
- 2 Solid Brass Body.
- 3 Anti-Pick Pin.
- 4 Stainless Steel Springs.
- 5 3 Keys.

FEATURES & APPLICATIONS

- Boat
- Boat trailer
- Boat engine
- Fence
- CHROME
- ANTI PICK PIN

Standard shackle

- Chrome Plated 30mm std. shackle
- Chrome Plated 40mm std. shackle
- Chrome Plated 50mm std. shackle

Long shackle

- Chrome Plated 30mm long shackle
- Chrome Plated 40mm long shackle
- Chrome Plated 50mm long shackle

For more details please see page 28

SOLID BRASS ARMORED PADLOCKS

OUTDOOR

25 +5
*25 years guarantee
25 años de garantía
Garantie 25 ans



The Stanley® Armored Padlock with a hardened steel case provides a high level of security for both professional and daily use. These padlocks utilize a hardened steel transverse bar that rotates to prevent saw attacks. To protect against drill attacks on the keyway, the cylinder employs an anti-drill plate. These features deliver the security that many other padlocks fail to provide which often results in property loss or damage.

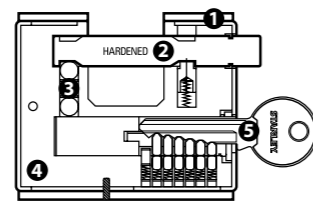

Armored Padlock

- 1 Steel Hardened Case.
- 2 Hardened Steel Transverse Bar.
- 3 Ball-Bearing Locking System.
- 4 Solid Brass Body.
- 5 3 Keys.

FEATURES & APPLICATIONS

- Container
- Shutter door
- Factory gate
- Truck
- STEEL
- ANTI PICK PIN

Solid Brass Armored Padlocks

- Solid Brass Armored 60mm
- Solid Brass Armored 80mm
- Solid Brass Armored 90mm

For more details please see page 29

SOLID BRASS BAYONETTE PADLOCKS

OUTDOOR

25 +5
*25 years guarantee
25 años de garantía
Garantie 25 ans



The Stanley® Bayonette Padlock is a great choice for both professional and daily use security needs. The bayonette design is ideal for rolling shutter doors or truck doors and prevents against bolt cutter attacks. These solid brass padlocks utilize a hardened-steel transverse bar that rotates to prevent saw attacks. In addition, the brass pins in the keyway and stainless steel springs deliver the long term performance you expect from the Stanley® brand.

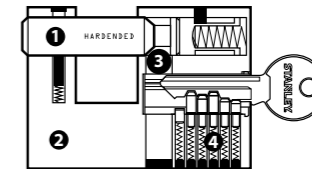

Bayonette Padlock

- 1 Hardened Steel Transverse Bar.
- 2 Solid Brass Body.
- 3 Ball-Bearing Locking System.
- 4 Stainless Steel Springs.

FEATURES & APPLICATIONS

- Container
- Shutter door
- Factory gate
- Truck
- STEEL
- BRASS

Solid Brass Bayonette Padlocks

- Solid Brass Bayonette 50mm
- Solid Brass Bayonette 70mm
- Solid Brass Bayonette 90mm

For more details please see page 29

SOLID BRASS PADLOCKS

OUTDOOR

25 +5
*25 years guarantee
25 años de garantía
Garantie 25 ans



The line of Stanley® standard shackle brass padlocks are suited for both indoor or outdoor use. Constructed with brass pins, stainless steel springs and a double locking hardened steel shackle, these locks deliver strength, security and peace of mind for residential and commercial applications.

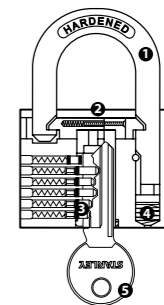

Standard Shackle Padlock

- 1 Double Locking Hardened Steel Shackle.
- 2 Solid Brass Body.
- 3 Anti-Pick Pins.
- 4 Stainless Steel Springs.
- 5 3 keys for single blister
5 keys for keyed alike multiblisters

Standard Shackle

- Solid Brass 20mm std. Shackle
- Solid Brass 25mm std. Shackle
- Solid Brass 30mm std. Shackle
- Solid Brass 40mm std. Shackle
- Solid Brass 50mm std. Shackle
- Solid Brass 60mm std. Shackle
- Solid Brass 70mm std. Shackle
- 2 Solid Brass 30mm std. Shackle
- 2 Solid Brass 40mm std. Shackle
- 2 Solid Brass 50mm std. Shackle
- 4 Solid Brass 40mm std. Shackle
- 4 Solid Brass 50mm std. Shackle

Long Shackle

- Solid Brass 20mm long Shackle
- Solid Brass 25mm long Shackle
- Solid Brass 30mm long Shackle
- Solid Brass 40mm long Shackle
- Solid Brass 50mm long Shackle

FEATURES & APPLICATIONS

- Truck
- Barn
- Garden
- Chain
- STEEL
- BRASS
- ANTI PICK PIN

For more details please see page 30-31

PRODUCTS

BARREL BRASS PADLOCKS

OUTDOOR

25 +5
*25 years guarantee
25 años de garantía
Garantie 25 ans



The Stanley® line of barrel padlocks offers you the protection required at the job site. The special design and construction allows for double the strength and security against crowbar attacks. Ideal for cargo trucks, vans, chains and hasps. The oversized shackle allows more strength against saw attacks.

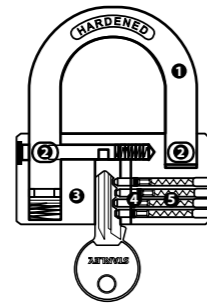

Barrel Brass Padlock

- ❶ Double Locking Hardened Steel Shackle.
- ❷ Double Locking Lever.
- ❸ Extra Wide And Extra Strong Solid Brass Body.
- ❹ Anti-Pick Pins.
- ❺ Stainless Steel Springs.

High SECURITY Barrel Brass Padlocks

Barrel Brass 30mm	Barrel Brass 70mm
Barrel Brass 40mm	Barrel Brass 80mm
Barrel Brass 50mm	

For more details please see page 32

FEATURES & APPLICATIONS

- Chain
- Rabbit hutch
- Garden
- Garden box
- BRASS
- ANTI PICK PIN

BRASS COMBINATION PADLOCKS

INDOOR

25 +5
*25 years guarantee
25 años de garantía
Garantie 25 ans



Stanley® Combination Padlocks are made with a high quality solid brass case and wheels designed to provide basic protection for indoor applications. Combination brass padlocks are superior for light duty usage such as securing luggage or storage lockers. They are available in both three and four number combinations.

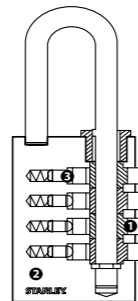

Combination Padlock

- ❶ Easy To Reset Combination. Up To 9999 Unique Combinations.
- ❷ Solid Brass Body.
- ❸ Brass Pins.

Combination Brass Padlock

Brass Combination 3 Digit 20mm	Brass Combination 4 Digit 30mm
Brass Combination 3 Digit 30mm	Brass Combination 4 Digit 40mm

For more details please see page 33

FEATURES & APPLICATIONS

- Toolbox
- Locker
- Money box
- COMBINATION
- BRASS

PADLOCKS CERTIFICATION

Stanley key operated padlocks are internally tested and measured against the standards of several different certification institutions, including the Australian Standard (AS), American Standard for Testing and Materials (ASTM), and British Standard European Norm (BS EN) testing standards. Our goal is to be transparent with all of our quality and security claims, helping you choose the right products for all of your security needs



Intertek Certification

Our key operated padlocks are also tested by an independent third party lab, Intertek, an industry leader in assurance, testing, inspection and certification services, under the Australian Standard. The Intertek certification grades drive the security level claims on our packaging, and the testing certificates are available on www.safeguard-lock.com



SBSC Certification

SBSC is an accredited Swedish certification institute that certifies products in the fields of fire protection and crime prevention. Their unique expertise contributes to maintaining a high level of quality in the products that they test and certify. These tests cover durability, corrosion resistance and security features, and products that receive this certification will include the SBSC logo on the packaging.

KEYED ALIKE

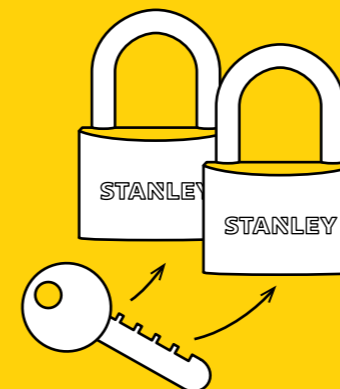

Keyed alike = one key fits all!

All multipacks are „keyed alike“ – this means that you can open all padlocks in the packaging with the same key. All multipacks come with 5 keys.

Your world. Truly secure.

PRODUCTS

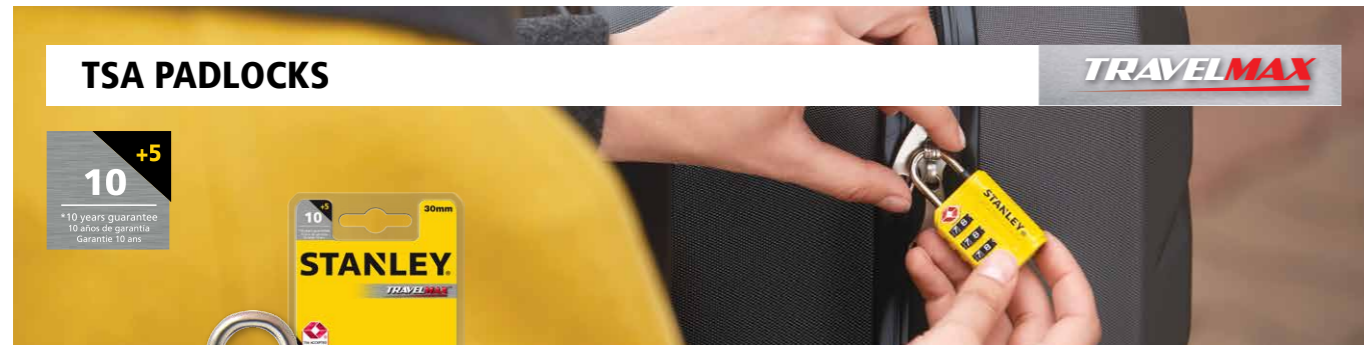

TSA PADLOCKS

TRAVELMAX

10
+5
*10 years guarantee
10 años de garantía
Garantie: 10 ans



TSA padlocks are a must-have product for travelers. Locking your luggage with a TSA approved padlock helps to protect your possessions from theft, tampering and misuse by smugglers. Travel Sentry Approved (TSA) padlocks can be opened and re-locked with a special key by the international security administration at every airport worldwide. Available in various attractive colors and finishes.

3 Digit green TSA Padlock

3 Digit green 30mm Zinc

Combo 2 keyed alike TSA Padlocks

Combo 2 keyed alike black/yellow 20mm Zinc

3 Digit TSA Padlocks with Indicator

- 3 Digit black 30mm Zinc Security Indicator
- 3 Digit red 30mm Zinc Security Indicator
- 3 Digit yellow 30mm Zinc Security Indicator

4 Digit TSA Padlocks

- 4 Digit black 30mm Zinc
- 4 Digit red 30mm Zinc
- 4 Digit yellow 30mm Zinc

3 Digit TSA Padlocks with flexible vinyl-coated Steel Cable

- 3 Digit black 20mm Zinc Vinyl Steel Cable
- 3 Digit yellow 20mm Zinc Vinyl Steel Cable

FEATURES & APPLICATIONS

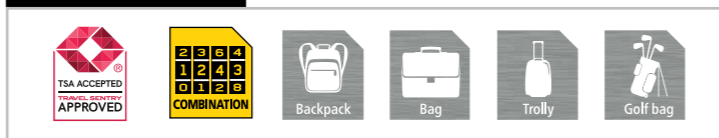

For more details please see page 36-37



TSA SPECIAL PADLOCK: SOCCER

TRAVELMAX

10
+5
*10 years guarantee
10 años de garantía
Garantie: 10 ans



Attractive football design. Travel Sentry Approved (TSA) lock: can be opened and re-locked with a special key by international security administration at every airport. Ideal for football excited people and countries. Perfect as a promotion for special football events like European Championship.

FEATURES & APPLICATIONS

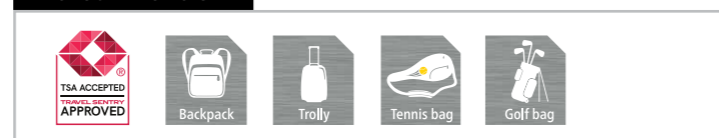

For more details please see page 37



TSA SPECIAL PADLOCK: WHITEBOARD

TRAVELMAX

10
+5
*10 years guarantee
10 años de garantía
Garantie: 10 ans



TSA approved padlocks are a must-have product for travelers. Locking your luggage with a TSA approved luggage lock helps to protect your possessions from theft, tampering and misuse by smugglers. Travel Sentry Approved padlocks can be opened and re-locked with a special key by the international security administration at every airport worldwide. This 3 Digit TSA approved combination padlock allows you to personalize your padlock with a marker for easy identification while securing your luggage.

3 Digit TSA approved Whiteboard

3 Digit 30mm TSA approved Whiteboard

For more details please see page 37

FEATURES & APPLICATIONS



LOVE LOCK

SPECIAL PADLOCKS



Jump on the international trend and place a heart shaped padlock at your favorite travel destination / location / place / spot. Heart shaped padlock as a symbol for your everlasting love and friendship. Perfect as a special gift for your sweetheart, family members, friends and other lovely people. Convenient for special occasions like Valentine`s Day, Mother`s Day, wedding, birthday, etc. Inscribe easily your personal initials with a permanent pen.

FEATURES & APPLICATIONS

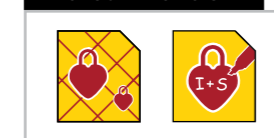

For more details please see page 35

FIFA WORLD CUP
RUSSIA 2018

CHOOSE YOUR SIDE



Choose your side

This 3 Digit TSA approved combination padlock allows you to personalize your padlock with a marker for easy identification while securing your luggage. The Promotional "Choose your side" package comes with various stickers of country flags to show your passion for your country plus heart-shaped soccer stickers to show your soccer love.

CHANNELS:



NEW

4 DIGIT CARABINER LOCK

SPECIAL PADLOCKS

incl. 180 cm removable and flexible leash

3⁺¹
*3 years guarantee
3 años de garantía
Garantie 3 ans



The Stanley® 4 Digit Carabiner Lock available in black and silver, including a 180cm flexible and removable leash, can be used to help prevent casual theft of your valuables while on quick stops (e.g. your helmet, bag, handbag, baby buggy, or your jacket.)

4 Digits allow you to set up to 9999 unique and individual code variations to secure your belongings.

FEATURES & APPLICATIONS



Carabiner Locks

Carabiner Lock 4 Digit 85mm silver

Carabiner Lock 4 Digit 85mm black

For more details please see page 35

STANLEY

BIKE LOCKS



HIGH SECURITY U-SHAPE LOCK

HIGH SECURITY

5⁺¹
*5 years guarantee
5 años de garantía
Garantie 5 ans



The Stanley® U-Shape lock offers you the protection you require when you want to lock your bike. The double deadbolt locking mechanism, the anti-drill disc cylinder, the frost tested and hardened steel shackle underline the high security performance. The U-Shape lock is due to its security features ideal for high valuable bikes and scooters.

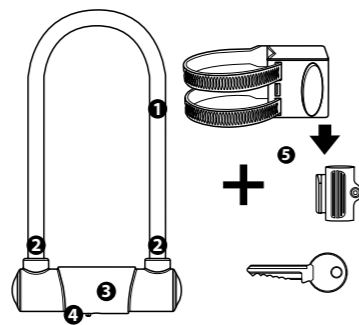

High Security U-Shape Lock

- 1 14mm Hardened Steel Shackle With Anti-Scratch Liner That Resists Bolt Cutters.
- 2 Double Deadbolt Locking Mechanism That Resists Pry Attacks.
- 3 High Security Anti-Drill Disc Cylinder.
- 4 ABS Housing Design With Special Rotating Dust Cover To Prevent Dirt And Water From Accessing The Mechanism.
- 5 Includes Holder That Mounts Almost Anywhere. 3 Keys.

High SECURITY U-Shape Lock

U-Shape 25cm ø14mm

For more details please see page 38

FEATURES & APPLICATIONS

- Mountain Bike
- Cross Bike
- Scooter
- Frost tested -20°C
- Anti-drill
- Anti-pry
- Weather resistant

KEY CABLE BIKE LOCK

MEDIUM SECURITY

3⁺¹
*3 years guarantee
3 años de garantía
Garantie 3 ans



The Stanley® cable lock with its flexible vinyl coated galvanized steel cable and its high security wafer cylinder provides the best operability when a flexible, light cable is needed. The cable locks come with a high quality metallic lock body with reinforced ABS housing for added strength and durability.

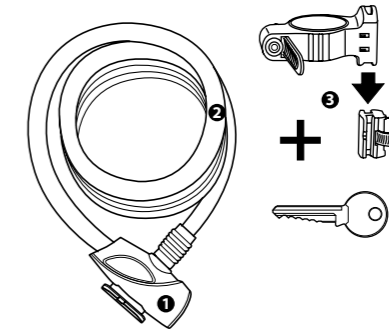

High Security Wafer Cylinder Bike Lock

- 1 High Quality Metallic Lock Body With Reinforced ABS Housing For Added Strength And Durability.
- 2 Flexible Vinyl Coated Galvanized Steel Cable For Strength, Flexibility And Rust Resistance.
- 3 Includes Holder That Mounts Almost Anywhere. 3 Keys.

Cable Key Bike Locks

Cable Key Bike Lock 90cm ø12mm

Cable Key Bike Lock 180cm ø12mm

For more details please see page 38

FEATURES & APPLICATIONS

- City Bike
- Mountain Bike
- Scooter
- Frost tested -20°C
- Anti-drill
- Anti-pry
- Weather resistant

COMBINATION CABLE BIKE LOCK

MEDIUM SECURITY

3⁺¹
*3 years guarantee
3 años de garantía
Garantie 3 ans



The Stanley® cable combination lock with its flexible vinyl coated galvanized steel cable provides the best operability when a flexible, light cable is needed. With its 4 digits resettable combinations it is the best solution for people who do not want to carry a key.

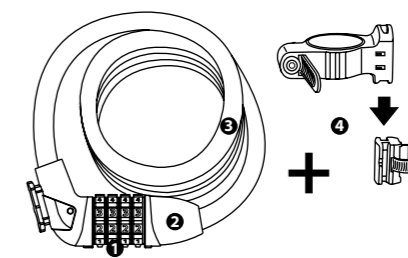

4-Digit Resettable Combination Bike Lock

- 1 Set Your Own Combination, No Key Needed.
- 2 High Quality Metallic Lock Body With ABS Housing.
- 3 Flexible Vinyl Coated Galvanized Steel Cable For Strength, Flexibility And Rust Resistance.
- 4 Includes Holder That Mounts Almost Anywhere.

4-Digit Resettable Combination Bike Locks

Cable Combination Bike Lock 90cm ø12mm

Cable Combination Bike Lock 180cm ø12mm

For more details please see page 38

FEATURES & APPLICATIONS

- City Bike
- Mountain Bike
- Scooter
- Frost tested -20°C
- COMBINATION
- Anti-drill
- Anti-pry
- Weather resistant

PRODUCTS

KEY CABLE FAMILY LOCKS

MEDIUM SECURITY

3⁺¹
*3 years guarantee
3 años de garantía
Garantie 3 ans



Stanley® Cable locks offer great protection for securing multiple bikes. These locks are ideal to secure bicycles in rural or suburban areas.

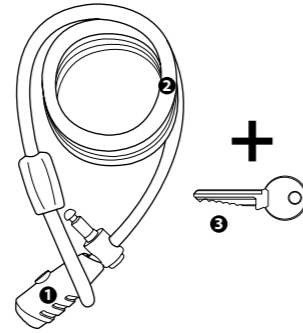

Cable Key Family Lock

- ❶ Strong Zinc Alloy Lock Body With Reinforced ABS Housing.
- ❷ Flexible Vinyl Coated Steel Cable.
- ❸ 3 Keys.

FEATURES & APPLICATIONS

- City Bike
- Mountain Bike
- BMX
- Frost tested -20°C
- Resistant to cutting
- Resistant to drilling
- Resistant to sawing

Cable Key Family Lock	
Medium	Cable Key Family Lock 240cm ø12mm
Standard	Cable Key Family Lock 240cm ø10mm

For more details please see page 39

KEY CABLE REFLECTIVE LOCK

MEDIUM SECURITY

3⁺¹
*3 years guarantee
3 años de garantía
Garantie 3 ans



Stanley® Cable locks offer great protection for all-day lock-ups. These locks are ideal to use in metropolitan areas during the day or night.

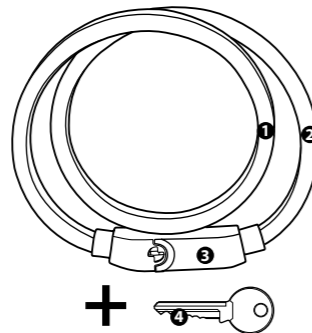

Cable Key Reflective Lock

- ❶ Strong Zinc Alloy Lock Body With Reinforced ABS Housing.
- ❷ 12mm Double-Wired Flat Cable Design For Added Strength.
- ❸ Reflective Cable For Added Safety During Night Rides.
- ❹ 3 Keys.

FEATURES & APPLICATIONS

- City Bike
- Mountain Bike
- Scooter
- Frost tested -20°C
- Resistant to cutting
- Resistant to drilling
- Resistant to sawing

Cable Key Reflective Lock	
	Cable Key Reflective Lock 120cm ø12mm

For more details please see page 39

KEY CABLE BIKE LOCKS

STANDARD SECURITY

3⁺¹
*3 years guarantee
3 años de garantía
Garantie 3 ans



Stanley® Cable locks are ideal for securing bikes, tool boxes, ladders, and small equipment for short-term lockup in rural areas and suburban areas.

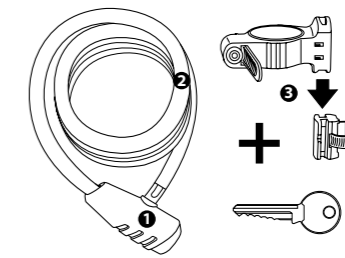

Cable Key Bike Lock

- ❶ Strong Zinc Alloy Lock Body With Reinforced ABS Housing.
- ❷ Flexible Vinyl Coated Steel Cable.
- ❸ Includes Holder That Mounts Almost Anywhere. 3 Keys.

FEATURES & APPLICATIONS

- City Bike
- Mountain Bike
- BMX
- Frost tested -20°C
- Resistant to cutting
- Resistant to drilling
- Resistant to sawing

Cable Key Bike Locks	
	Cable Key Bike Lock 180cm ø10mm
	Cable Key Bike Lock 90cm ø10mm

For more details please see page 39

COMBINATION CABLE BIKE LOCKS

STANDARD SECURITY

3⁺¹
*3 years guarantee
3 años de garantía
Garantie 3 ans



Stanley® Cable locks are ideal for securing bikes, tool boxes, ladders, and small equipment for short-term lockup in rural areas and suburban areas.

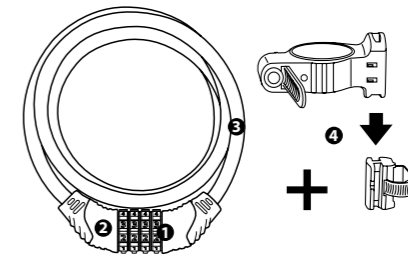

Cable Combination Bike Lock

- ❶ Set Your Own Combination, No Key Needed.
- ❷ Strong Zinc Alloy Lock Body With Reinforced ABS Housing.
- ❸ Flexible Vinyl Coated Steel Cable.
- ❹ Includes Holder That Mounts Almost Anywhere.

FEATURES & APPLICATIONS

- City Bike
- Mountain Bike
- BMX
- Frost tested -20°C
- Resistant to cutting
- Resistant to drilling
- Resistant to sawing

Cable Combination Bike Locks	
	Cable Combination Bike Lock 180cm ø10mm
	Cable Combination Bike Lock 90cm ø10mm

For more details please see page 39

ASSORTMENT OVERVIEW

CHROME PLATED, STEEL



ALL-WEATHER

Product	Solid Brass Chrome Plated 30mm Std. Shackle	Solid Brass Chrome Plated 40mm Std. Shackle	Solid Brass Chrome Plated 50mm Std. Shackle	Solid Brass Chrome Plated 30mm Long Shackle	Solid Brass Chrome Plated 40mm Long Shackle	Solid Brass Chrome Plated 50mm Long Shackle
VKB-No.	81050 371 401	81051 371 401	81052 371 401	81060 371 401	81061 371 401	81062 371 401
S-No.	5742-011	5742-012	5742-013	5742-015	5742-016	5742-017
Consumer unit	1	1	1	1	1	1
Padlock	Width (mm)	30	40	50	30	40
	Height (mm) total	49	62,4	78	79,1	104
	Depth (mm)	12,8	14	16,6	12,7	14
	Weight (g)	76	134	247	83	155
Blister	Width (mm)	97	97	97	97	147
	Height (mm)	192	192	192	192	192
	Depth (mm)	20	22	25	20	22
	Weight (g)	96	158	277	105	178
Units Innercarton	6	6	6	6	6	6
Units Mastercarton	18	18	18	18	18	18
Keys	3	3	3	3	3	3
Additional Key Information	Key Type: Universal	Key Type: Universal	Key Type: Universal	Key Type: Universal	Key Type: Universal	Key Type: Universal
Body	Solid Brass	Solid Brass	Solid Brass	Solid Brass	Solid Brass	Solid Brass
Shackle	Stainless Steel	Stainless Steel	Stainless Steel	Stainless Steel	Stainless Steel	Stainless Steel
Guarantee	25 + 5 Years	25 + 5 Years	25 + 5 Years	25 + 5 Years	25 + 5 Years	25 + 5 Years
Details	Page 16	Page 16	Page 16	Page 16	Page 16	Page 16
EAN						

ARMORED & BAYONETTE BRASS PADLOCKS



OUTDOOR

Product	Solid Brass Armored 60mm	Solid Brass Armored 80mm	Solid Brass Armored 90mm	Solid Brass Bayonette 50mm	Solid Brass Bayonette 70mm	Solid Brass Bayonette 90mm
VKB-No.	81080 372 401	81081 372 401	81082 372 401	81090 371 401	81091 371 401	81092 371 401
S-No.	5742-022	5742-023	5742-024	5742-025	5742-026	5742-027
Consumer unit	1	1	1	1	1	1
Padlock	Width (mm)	60	80	90	50	70
	Height (mm) total	54,5	68,9	76	38	48
	Depth (mm)	25	29	30	15	17
	Weight (g)	437	796	1.001	181	375
Blister	Width (mm)	147	147	147	97	147
	Height (mm)	192	192	192	192	192
	Depth (mm)	30	37	35	21,5	23
	Weight (g)	486	834	1.059	216	446
Units Innercarton	6	6	6	6	6	6
Units Mastercarton	18	18	18	18	18	18
Keys	3	3	3	3	3	3
Additional Key Information	Key Type: Universal	Key Type: Universal	Key Type: Universal	Key Type: Universal	Key Type: Universal	Key Type: Universal
Body	Solid Brass	Solid Brass	Solid Brass	Solid Brass	Solid Brass	Solid Brass
Shackle	Hardened Steel	Hardened Steel	Hardened Steel	Hardened Steel	Hardened Steel	Hardened Steel
Guarantee	25 + 5 Years	25 + 5 Years	25 + 5 Years	25 + 5 Years	25 + 5 Years	25 + 5 Years
Details	Page 16	Page 16	Page 16	Page 17	Page 17	Page 17
EAN						

ASSORTMENT OVERVIEW

BRASS PADLOCKS



OUTDOOR

Product	Solid Brass 20mm Std. Shackle	Solid Brass 25mm Std. Shackle	Solid Brass 30mm Std. Shackle	Solid Brass 40mm Std. Shackle	Solid Brass 50mm Std. Shackle	Solid Brass 60mm Std. Shackle	Solid Brass 70mm Std. Shackle	2 Solid Brass 30mm Std. Shackle	
VKB-No.	81100 371 401	81101 371 401	81102 371 401	81103 371 401	81104 371 401	81105 371 401	81106 371 401	81102 371 402	
S.No.	S742-028	S742-029	S742-030	S742-031	S742-032	S742-033	S742-034	S742-035	
Consumer unit	1	1	1	1	1	1	1	2	
Padlock	Width (mm)	20	25	30	40	50	60	70	30
	Height (mm) total	35,5	43,5	49,5	62,3	77,7	88,8	101	49,5
	Depth (mm)	10	11,4	12,7	14,3	16,5	18	19,3	12,7
	Weight (g)	28,8	46,5	74,2	132	244	350	519	74,2
Blister	Width (mm)	97	97	97	97	97	147	147	147
	Height (mm)	192	192	192	192	192	192	192	192
	Depth (mm)	22	18	21	23	25	27	25	22
	Weight (g)	57	74	110	170	286	422	585	194
Units Innercarton	6	6	6	6	6	6	6	6	
Units Mastercarton	18	18	18	18	18	18	18	18	
Keys	3	3	3	3	3	3	3	5	
Additional Key Information	Key Type: Universal	Key Type: Universal	Key Type: Universal	Key Type: Universal	Key Type: Universal	Key Type: Universal	Key Type: Universal	Key Type: Universal, keyed alike	
Body	Solid Brass	Solid Brass	Solid Brass	Solid Brass	Solid Brass	Solid Brass	Solid Brass	Solid Brass	
Shackle	Hardened Steel	Hardened Steel	Hardened Steel	Hardened Steel	Hardened Steel	Hardened Steel	Hardened Steel	Hardened Steel	
Guarantee	25 + 5 Years	25 + 5 Years	25 + 5 Years	25 + 5 Years	25 + 5 Years	25 + 5 Years	25 + 5 Years	25 + 5 Years	
Details	Page 17	Page 17	Page 17	Page 17	Page 17	Page 17	Page 17	Page 17	
EAN									

BRASS PADLOCKS



OUTDOOR





2 Solid Brass 40mm Std. Shackle	2 Solid Brass 50mm Std. Shackle	4 Solid Brass 40mm Std. Shackle	4 Solid Brass 50mm Std. Shackle	Solid Brass 20mm long Shackle	Solid Brass 25mm long Shackle	Solid Brass 30mm long Shackle	Solid Brass 40mm long Shackle	Solid Brass 50mm long Shackle
81103 371 402	81104 371 402	81103 371 404	81104 371 404	81110 371 401	81111 371 401	81112 371 401	81113 371 401	81114 371 401
S742-036	S742-037	S742-038	S742-039	S742-040	S742-041	S742-042	S742-043	S742-044
2	2	4	4	1	1	1	1	1
40	50	40	50	20	25	30	40	50
62,3	77,7	62,3	77,7	47,2	55,6	66	81,1	124,7
14,3	16,5	14,3	16,5	10,4	11,4	12,7	14,3	17,2
132	244	132	244	30	49,5	78,1	142,2	277
147	147	147	147	97	97	97	97	147
192	192	267	267	192	192	192	192	192
25	26	24	28	21	21	22	23	24
336	557	590	1.063	51	80	114	181	349
6	6	6	6	6	6	6	6	6
18	18	18	18	18	18	18	18	18
5	5	5	5	3	3	3	3	3
Key Type: Universal, keyed alike	Key Type: Universal, keyed alike	Key Type: Universal, keyed alike	Key Type: Universal, keyed alike	Key Type: Universal	Key Type: Universal	Key Type: Universal	Key Type: Universal	Key Type: Universal
Solid Brass	Solid Brass	Solid Brass	Solid Brass	Solid Brass	Solid Brass	Solid Brass	Solid Brass	Solid Brass
Hardened Steel	Hardened Steel	Hardened Steel	Hardened Steel	Hardened Steel	Hardened Steel	Hardened Steel	Hardened Steel	Hardened Steel
25 + 5 Years	25 + 5 Years	25 + 5 Years	25 + 5 Years	25 + 5 Years	25 + 5 Years	25 + 5 Years	25 + 5 Years	25 + 5 Years
Page 17	Page 17	Page 17	Page 17	Page 17	Page 17	Page 17	Page 17	Page 17

ASSORTMENT OVERVIEW

BARREL BRASS PADLOCKS

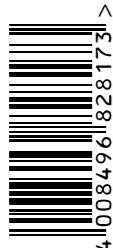

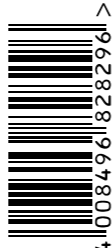



OUTDOOR

Product	Barrel Brass 30mm	Barrel Brass 40mm	Barrel Brass 50mm	Barrel Brass 70mm	Barrel Brass 80mm	
VKB-No.	81120 371 401	81121 371 401	81122 371 401	81123 371 401	81124 371 401	
S-No.	S742-045	S742-046	S742-047	S742-048	S742-049	
Consumer unit	1	1	1	1	1	
Padlock	Width (mm)	30	40	50	70	80
	Height (mm) total	35,5	51,9	60,6	78,2	89,9
	Depth (mm)	16,5	21,7	23,6	33,5	30,8
	Weight (g)	59,1	142	213	479	676
Blister	Width (mm)	97	97	97	147	147
	Height (mm)	192	192	192	192	192
	Depth (mm)	22	25	29	32	36
	Weight (g)	87	177	242	527	731
Units Innercarton	6	6	6	6	6	
Units Mastercarton	18	18	18	18	18	
Keys	3	3	3	3	3	
Additional Key Information	Key Type: Universal	Key Type: Universal	Key Type: Universal	Key Type: Universal	Key Type: Universal	
Body	Solid Brass	Solid Brass	Solid Brass	Solid Brass	Solid Brass	
Shackle	Hardened Steel	Hardened Steel	Hardened Steel	Hardened Steel	Hardened Steel	
Guarantee	25 + 5 Years	25 + 5 Years	25 + 5 Years	25 + 5 Years	25 + 5 Years	
Details	Page 18	Page 18	Page 18	Page 18	Page 18	
EAN	 4 008496 182817 3	 4 008496 182821 0	 4 008496 182825 8	 4 008496 182829 6	 4 008496 182833 3	

COMBINATION BRASS PADLOCKS



INDOOR

Product	Brass Combination 3 Digit 20mm	Brass Combination 3 Digit 30mm	Brass Combination 4 Digit 30mm	Brass Combination 4 Digit 40mm	
VKB-No.	81130 371 401	81131 371 401	81132 371 401	81133 371 401	
S-No.	S742-050	S742-051	S742-052	S742-053	
Consumer unit	1	1	1	1	
Padlock	Width (mm)	20	30	30	40
	Height (mm) total	54,8	73,4	86,1	86,7
	Depth (mm)	13,5	15,9	15,8	15,8
	Weight (g)	47,8	118,7	177	212
Blister	Width (mm)	97	97	97	97
	Height (mm)	192	192	192	192
	Depth (mm)	18	20	20	22
	Weight (g)	53	124	182	211
Units Innercarton	6	6	6	6	
Units Mastercarton	18	18	18	18	
Keys	-	-	-	-	
Additional Key Information	-	-	-	-	
Body	Solid Brass	Solid Brass	Solid Brass	Solid Brass	
Shackle	Hardened Steel	Hardened Steel	Hardened Steel	Hardened Steel	
Guarantee	25 + 5 Years	25 + 5 Years	25 + 5 Years	25 + 5 Years	
Details	Page 18	Page 18	Page 18	Page 18	
EAN	 4 008496 182837 1	 4 008496 182841 8	 4 008496 182640 7	 4 008496 182845 6	

ASSORTMENT OVERVIEW

PROFESSIONAL SECURITY 24/7



ALL-WEATHER							
Product	24/7 Solid Brass 50mm Std. Shackle	24/7 Solid Brass 50mm long Shackle	24/7 Laminated 50mm, Std. Shackle shrouded	24/7 Laminated 50mm Std. Shackle	2x 24/7 Laminated 50mm Std. Shackle	24/7 Laminated 60mm longer Shackle	
VKB-No.	81020 361 501	81021 361 501	81030 363 501	81031 363 501	81031 363 502	81032 363 501	
S-No.	5742-002	5742-003	5742-004	5742-005	5742-006	5742-007	
Consumer unit	1	1	1	1	2	1	
Padlock	Width (mm)	50	50	50	50	60	
	Height (mm) total	114,6	141	113,5	96,4	111,2	
	Depth (mm)	31,3	31,3	29	27	32,5	
	Weight (g)	600	620	565	535	535	797
Blister	Width (mm)	98	98	98	98	199	123
	Height (mm)	216	192	170	170	170	170
	Depth (mm)	37	37	37	37	37	37
	Weight (g)	686	696	677	632	1.266	875
Units Innercarton	2	2	2	2	2	2	
Units Mastercarton	16	16	16	16	16	16	
Keys	2	2	2	2	4	2	
Additional Key Information	Key Type: SC	Key Type: SC	Key Type: SC	Key Type: SC	Key Type: SC	Key Type: SC	
Body	Solid Brass	Solid Brass	Laminated Steel	Laminated Steel	Laminated Steel	Laminated Steel	
Shackle	Stainless Steel	Stainless Steel	Hardened Molybdenum Alloy	Hardened Molybdenum Alloy	Hardened Molybdenum Alloy	Hardened Molybdenum Alloy	
Guarantee	30 Years	30 Years	30 Years	30 Years	30 Years	30 Years	
Details	Page 14	Page 14	Page 15	Page 15	Page 15	Page 15	
EAN							

SPECIAL LOCKS



ALL-WEATHER		SPECIAL LOCKS			
Product	24/7 Shrouded Padlock 50mm + Hasp	3 Digit Love Lock	4 Digit Carabiner Lock, silver	4 Digit Carabiner Lock, black	
VKB-No.	81041 361 401	81200 373 401	81204 396 401	81203 396 401	
S-No.	5742-009	5742-065	5744-031	5744-030	
Consumer unit	1	1	1	1	
Padlock	Width (mm)	50	30	87	87
	Height (mm) total	74,4	64,3	52,5	52,5
	Depth (mm)	20,8	9,9	3,8	3,8
	Weight (g)	588	55,2	TBD	TBD
Blister	Width (mm)	217	97	97	97
	Height (mm)	261	192	192	192
	Depth (mm)	38	17	29	29
	Weight (g)	784	80	0,107	0,107
Units Innercarton	-	6	6	6	
Units Mastercarton	5	36	18	18	
Keys	2	-	-	-	
Additional Key Information	Key Type: Universal	-	-	-	
Body	Solid Brass	Zinc	Zinc	Zinc	
Shackle	Hardened Steel	Steel	Steel	Steel	
Guarantee	30 Years	-	3+1 Years	3+1 Years	
Details	Page 15	Page 21	Page 23	Page 23	
EAN					

ASSORTMENT OVERVIEW

TSA PADLOCKS



TRAVELMAX™

Product	3 Digit black 30mm Zinc Security Indicator	3 Digit red 30mm Zinc Security Indicator	3 Digit yellow 30mm, Zinc Security Indicator	4 Digit black 30mm Zinc	4 Digit red 30mm Zinc	4 Digit yellow 30mm, Zinc
VKB-No.	81140 393 401	81141 393 401	81142 393 401	81150 393 401	81151 393 401	81152 393 401
S-No.	5742-054	5742-055	5742-056	5742-057	5742-058	5742-059
Consumer unit	1	1	1	1	1	1
Padlock	Width (mm)	30	30	30	30	30
	Height (mm) total	60,4	60,4	60,4	65,5	65,5
	Depth (mm)	14,1	14,1	14,1	15	15
	Weight (g)	64,7	64,7	64,7	58,7	58,7
Blister	Width (mm)	97	97	97	97	97
	Height (mm)	192	192	192	192	192
	Depth (mm)	20	20	20	22	22
	Weight (g)	87	87	87	81	81
Units Innercarton	6	6	6	6	6	6
Units Mastercarton	36	36	36	36	36	36
Keys	-	-	-	-	-	-
Additional Key Information	-	-	-	-	-	-
Body	Zinc	Zinc	Zinc	Zinc	Zinc	Zinc
Shackle	Steel	Steel	Steel	Steel	Steel	Steel
Guarantee	10 + 5 Years	10 + 5 Years	10 + 5 Years	10 + 5 Years	10 + 5 Years	10 + 5 Years
Details	Page 20	Page 20	Page 20	Page 20	Page 20	Page 20
EAN						

TSA PADLOCKS







TRAVELMAX™

3 Digit black 20mm Zinc Vinyl Steel Cable	3 Digit yellow 20mm, Zinc Vinyl Steel Cable	Combo 2 Keyed Alike, Black/Yellow 20mm Zinc	3 Digit white 30mm, Zinc	3 Digit Whiteboard Soccer Promotion	3 Digit green 30mm Zinc	Keyed Soccer Shaped 30 mm
81160 393 401	81161 393 401	81181 393 401	81144 393 401	81145 393 401	81143 393 401	81201 373 401
5742-060	5742-061	5742-064	5741-165	5888-001	5744-011	5742-067
1	1	1	1	1	1	1
20	20	20	30	30	30	30
83,2	83,2	40,4	59,5	59,5	56,4	45,6
19,2	19,2	14,3	12,15	12,15	15	30,8
46,4	46,4	94	22,5	22,5	30,4	34,4
97	97	97	97	97	97	97
192	192	192	192	192	192	192
24	24	21	20	20	21	37
70	70	95	45	45	76	55
6	6	6	6	6	-	5
36	36	36	36	36	20	30
-	-	2	-	-	-	2
-	-	No Key Copy possible	-	-	-	No Key Copy possible
Zinc	Zinc	Zinc	Zinc	Zinc	Zinc	Zinc
Plastic Coated + Wire	Plastic Coated + Wire	Steel	Steel	Steel	Steel	Steel
10 + 5 Years	10 + 5 Years	10 + 5 Years	10 + 5 Years	10 + 5 Years	10 + 5 Years	10 + 5 Years
Page 20	Page 20	Page 20	Page 21	Page 22	Page 20	Page 20

ASSORTMENT OVERVIEW







BIKE LOCKS



		HIGH	MEDIUM			
Product		U-Shape Bike Lock ø 14x247	Key Cable Bike Lock ø 12x1800	Key Cable Bike Lock ø 12x900	Combination Cable Bike Lock ø 12x1800	Combination Cable Bike Lock ø 12x900
VKB-No.		81301 385 111	81310 385 111	81311 385 111	81320 385 111	81321 385 111
S-No.		S755-201	S755-202	S755-203	S755-204	S755-205
Consumer unit		1	1	1	1	1
Padlock	Width (mm)	167	130	175	130	175
	Height (mm) total	247	180	225	180	225
	Depth (mm)	55	65	37	65	37
	Weight (g) *incl. holder	1066	550	339	618	415
Blister	Width (mm)	167	130	175	130	175
	Height (mm)	247	180	225	180	225
	Depth (mm)	55	65	37	65	37
	Weight (g)	1.118	602	391	658	455
Units Innecarton		4	4	4	4	4
Units Mastercarton		8	8	8	8	8
Keys		3	3	3	-	-
Additional Key Information		-	-	-	-	-
Body		-	Strong Zinc Alloy Lock Body with ABS Housing	Strong Zinc Alloy Lock Body with ABS Housing	Strong Zinc Alloy Lock Body with ABS Housing	Strong Zinc Alloy Lock Body with ABS Housing
Shackle		Hardened Steel	-	-	-	-
Guarantee		5 + 1 Years	3 + 1 Years	3 + 1 Years	3 + 1 Years	3 + 1 Years
Details		Page 24	Page 25	Page 25	Page 25	Page 25
EAN						

BIKE LOCKS

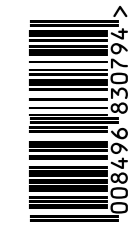

		MEDIUM		STANDARD				
Product		Key Cable Reflective Lock ø 12x1200	Key Cable Family Lock ø 12x2400	Key Cable Family Lock ø 10x2400	Key Cable Bike Lock ø 10x900	Key Cable Bike Lock ø 10x1800	Combination Cable Bike Lock ø 10x900	Combination Cable Bike Lock ø 10x1800
VKB-No.		81316 385 111	81315 385 111	81314 385 111	81313 385 111	81312 385 111	81323 385 111	81322 385 111
S-No.		S741-161	S741-163	S741-159	S741-155	S741-157	S741-151	S741-153
Consumer unit		1	1	1	1	1	1	1
Width (mm)		176	160	130	177	131	177	150
Height (mm) total		197	345	255	209	160	167	128
Depth (mm)		55	50	48	38	63	40	63
Weight (g) *incl. holder		740	777	477	214	343	199	314
Width (mm)		176	160	130	177	131	177	150
Height (mm)		197	345	255	209	160	167	128
Depth (mm)		55	50	48	38	63	40	63
Weight (g)		770	804	509	236	358	217	330
Units Innecarton		4	4	4	4	4	4	4
Units Mastercarton		8	8	8	8	8	8	8
Keys		3	3	3	3	3	-	-
Additional Key Information		-	-	-	-	-	-	-
Body		Strong Zinc Alloy Lock Body with ABS Housing	Strong Zinc Alloy Lock Body with ABS Housing	Strong Zinc Alloy Lock Body with ABS Housing	Strong Zinc Alloy Lock Body with ABS Housing	Strong Zinc Alloy Lock Body with ABS Housing	Strong Zinc Alloy Lock Body with ABS Housing	Strong Zinc Alloy Lock Body with ABS Housing
Shackle		-	-	-	-	-	-	-
Guarantee		3 + 1 Years	3 + 1 Years	3 + 1 Years	3 + 1 Years	3 + 1 Years	3 + 1 Years	3 + 1 Years
Details		Page 26	Page 26	Page 26	Page 27	Page 27	Page 27	Page 27
EAN								

ASSORTMENT OVERVIEW

DISPLAYS



Product	BIKE LOCK		TRAVELMAX™		
	Bike Lock Floor Stand Display	Bike Lock Floor Stand Display	TSA Metal Rail	TSA Clipstrip	TSA Mix Counter
VKB-No.	88069 112 801	88069 112 811	87040 112 801	87340 112 801	86340 112 811
S-No.	5744-010	5744-013	5744-003	5744-006	5890-032
Display	Blister amount	50	28	2 x 10	32
	Width (mm)	400	97	97	450
	Height (mm) *without crouter	*1.480	1000	1000	200*
	Depth (mm)	590	120	21	280
Hooks / Facings	14	14	4	10	4
Hook Length (mm)	200	200	120	-	-
Garnishing	3 Hook à 3 pieces 81310 385 111 3 Hooks à 3 pieces 81320 385 111 2 Hooks à 5 pieces 81311 385 111 2 Hooks à 5 pieces 81321 385 111 4 Hooks à 3 pieces 81301 385 111 In Total: 50 Blister	9x S741-153 Cable Combi in 3 facings 9x S741-157 Cable Key in 3 facings 6x S741-161 Cable Key Reflective in 2 facings 6x S755-201 U Shape in 2 facings 10x S741-151 Cable Combi in 2 facings 10x S741-155 Cable Key in 2 facings	4 x 81140 393 401 4 x 81142 393 401 4 x 81160 393 401 4 x 81161 393 401 In Total: 16 Blister	10 Blister per Clipstrip 2 Clipstrip per Carton	16 x S742-054 3 Digit 30mm black Indicator 8 x S742-055 3 Digit 30mm red Indicator 8x S742-061 3 Digit 20mm vinyl yellow Total: 32 blister
Details	Page 13	Page 13	Page 12	Page 12	Page 12
EAN					

DISPLAYS



TRAVELMAX™	SPECIAL			TRAVELMAX™	PADLOCKS
Whiteboard Promo TSA Counter	Love Lock Counter	Carabiner Counter	Love Lock Floor Display	Mixed TSA Floor Display	Mixed Padlock Floor Display
86340 112 801	86350 112 801	86369 112 801	88150 112 801	88140 112 801	88100 112 801
5890-031	5890-033	5890-034	5744-016	5744-015	5744-014
32	32	32	60	54	60
450	450	450	400	400	400
200*	200*	200*	*1.010	*1.010	*1.010
280	280	280	600	600	600
4	4	4	10 facings	10 facings	10 facings
-	-	-	-	-	-
32 x S888-001 Whiteboard Promo TSA	32 x S742-065 Love Lock	16 x S744-030 Carabiner black in 2 facings 16 x S744 - 031 Carabiner silver in 2 facings Total: 32 blister	per facing 6 x 81200 373 401 In Total: 60 Blister	12 x S742-054 Indicator Black in 2 facings 6 x S742-056 Indicator Yellow in 1 facing 10 x S742-061 Vinyl Yellow in 2 facings 10 x S741-165 Whiteboard in 2 facings 6 x S742-055 Indicator Red in 1 facing 10 x S742-060 Vinyl Black in 2 facings In Total: 54 Blister	12 x 81102 371 401 in 2 facings 12 x 81112 371 401 in 2 facings 12 x 81131 371 401 in 2 facings 12 x 81101 371 401 in 2 facings 12 x 81111 371 401 in 2 facings In Total: 60 Blister
Page 12	Page 12	Page 12	Page 13	Page 13	Page 13

OUR PADLOCK FEATURES

STANLEY PADLOCKS

	Solid Brass Chrome Plated							
	Solid Brass Armored							
	Solid Brass Bayonette							
	Solid Brass							
	Barrel Brass							
	Brass Combination							

STANLEY PROFESSIONAL SECURITY 24/7

	24/7 Solid Brass security							
	24/7 Laminated security							
	24/7 Premium Shrouded padlock + HASP							

STANLEY TSA

	TSA padlock							
--	--------------------	--	--	--	--	--	--	--

TSA: the international standard for Travel Security
TSA Approved locks: can be opened and re-locked with a special key by international security administration at every airport

OUR BIKE LOCK FEATURES

	High Security U-Shape Lock						
	Key Cable Bike Lock						
	Combination Cable Bike Lock						
	Key Cable Family Lock						
	Key Cable Reflective Lock						

GOOD TO KNOW

	DOUBLE LOCKING SHACKLE Internal locking mechanism engages both side of shackle providing higher security compared to single locking mechanism.		FROST TESTED Frost tested Bikelocks are tested to -20 degrees celsius to ensure that the products can withstand extreme temperatures.
	CHROME PLATED This Padlock has an outer layer of chrome which increases the hardness of the padlock and provides higher corrosion resistance for salty or caustic environments.		CUT RESISTANCE Cable / shackle with good cut resistance.
	DUAL BALL BEARING Stainless Steel ball-bearing mechanism which holds the shackle firmly in place and adds maximum protection against pry attacks.		SAWING RESISTANCE Cable / shackle with good saw resistance.
	ANTI PICK PIN The anti pick pin has a special mushroom shape which makes it harder to pick and prevents the cylinder from being operated without a key.	<div style="border: 1px solid black; padding: 10px;"> <p>! GUARANTEE EXTENSION with registration on www.safeguard-lock.com</p> <div style="display: flex; align-items: center;"> <div style="border: 2px solid black; padding: 5px; margin-right: 10px;"> <p style="font-size: 24px; font-weight: bold; margin: 0;">10</p> <p style="font-size: 10px; margin: 0;">*25 years guarantee Garantie 25 ans 25 años de garantía</p> </div> <div style="margin: 0;"> <p style="font-size: 12px; margin: 0;">Guarantee extension</p> <p style="font-size: 12px; margin: 0;">Standard guarantee period</p> </div> </div> <ul style="list-style-type: none"> ✓ increase awareness on products ✓ Increase awareness for webpage ✓ Give consumer a truly secure feeling in quality and customer service ✓ Make them feel that they are in „good hands“ </div>	
	SOLID BRASS BODY The brass body provides protection for the internal mechanism of the lock. Brass is also a metal alloy with high corrosion resistance.		
	NO KEY REMOVAL Key can be removed in closed position. Prevents accidentally locking the key inside or losing keys.		
	SHROUDED BODY The padlock shackle is covered providing maximum protection against cutting and pry attacks. It prevents the use of traditional bolt cutters.		
	PROTECTION AGAINST DRILLING ATTACKS A special disc rotates when the padlock cylinder is attacked by a drill. The drill turns loose and cannot penetrate the cylinder.		

5 Questions to find the right padlock

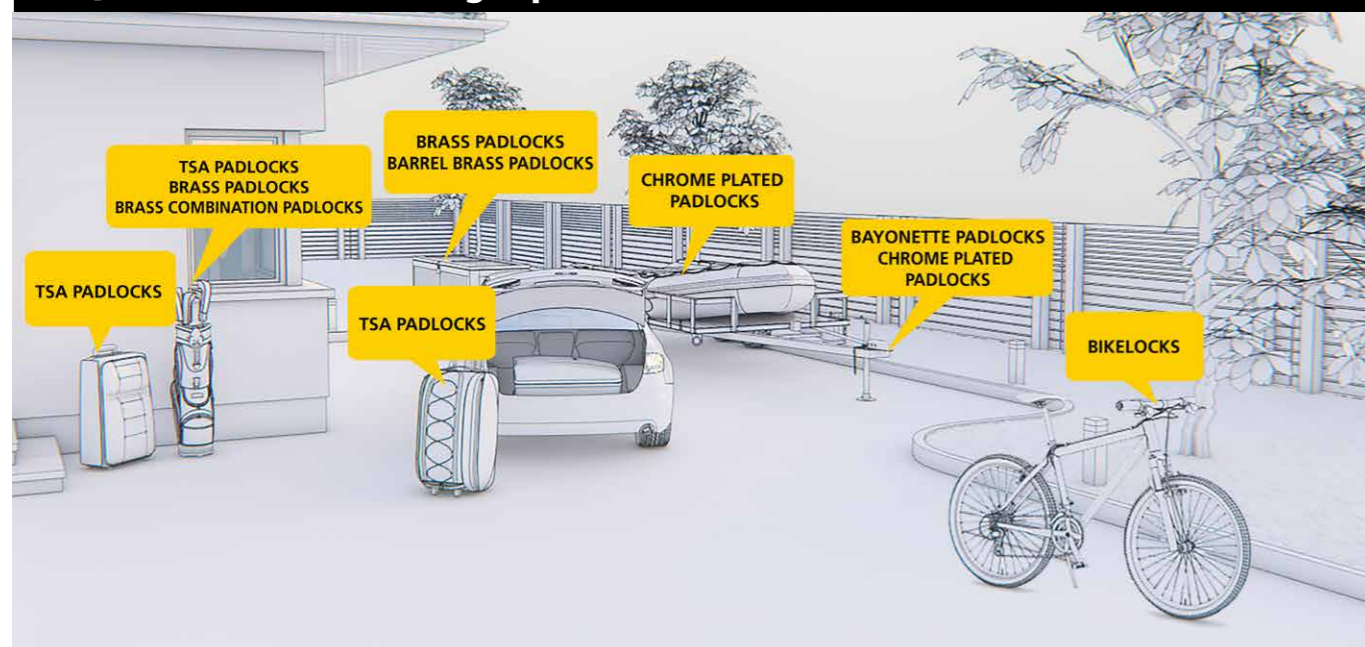

1 Which item do you want to secure and how valuable is it?

- If the item is not so valuable you can use a padlock with a lower security level.
- If the item is valuable you should buy a padlock with a higher security level.

2 For which application do you need the padlock?

- Define the usage of your padlock – indoor, outdoor or travel-high security or low security.
- Check if the padlock chosen matches the required performance of the padlock.
- Please notice that size alone is not the only indicator to choose the right padlock, it needs to have the right security level to match its purpose.
- Check to make sure the shackle will fit into the item you would like to secure.

3 Are there special requirements concerning the lock system/mechanism?

- If you need more padlocks that can be locked and unlocked with a single key, you should use „Keyed Alike“ padlocks.
- If many people would like to share one padlock, you can use a combination padlock. The advantage is that you do not need many keys for lots of people. Please notice that combination padlocks are suitable for applications with a lower security level.

4 What is the right padlock and shackle size?

- The padlock should be the appropriate size for the required usage.
- Check additional padlock features like shackle size, diameter & material, body material & finish and to match the surrounding components and area.
- Short or long shackle size? The shackle size depends on the usage of the padlock. To pass through hasps and fittings with a long distance, a long shackle is required.
- Additionally the diameter and material of the shackle are further points to take into consideration for better security. Please pay attention to the shackle diameter and that it fits into the desired hole for locking.

5 What type of body should I choose?

- The purpose of the padlock body is to protect the lock system against attacks.
- The main body types are Solid Brass, Laminated Steel and Armored Encased Brass.
- Solid Brass: Brass is a softer material that is easy for manufacturers to machine resulting in lower prices for customers, but brass padlocks are more susceptible to drill attacks than padlocks made of harder materials. Brass padlocks typically have sharp corners which can scratch some surfaces.
- Laminated Steel: The body of this type is designed from separate thin steel plates which are riveted together. Low production costs enable low prices for customers.
- Armored Encased Brass: The brass body is encased in hardened steel for better protection against drilling attacks and to achieve a higher security level.

Padlock care and maintenance



Normally padlocks & bike locks need minimal care. For combination padlocks and bike locks there is no special maintenance required.

To care for outdoor padlocks and key operated bike locks, lubricate the cylinder once or twice a year.

Bike lock security tips

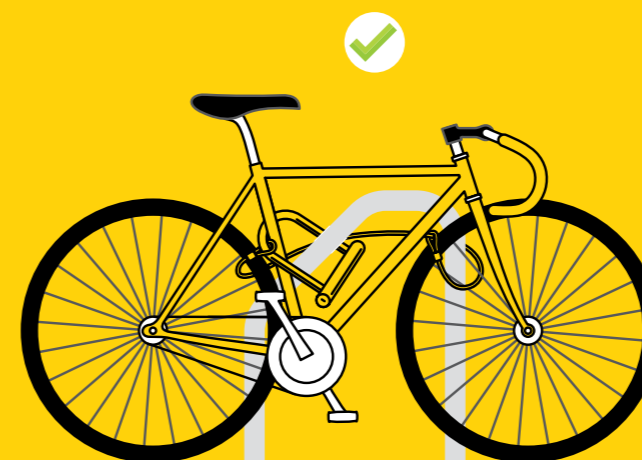

Lock your bike to a fixed object

such as streetlight or secure fence. To make sure the lock is secured properly, pull your bike away from the lock to create a small amount of pressure.

The Bike Lock should not touch the ground, so thieves cannot benefit from creating leverage to break the lock.

Choose busy storage locations with high visibility, where thieves are less likely to operate.

Ensure both your tire and frame are securely locked.

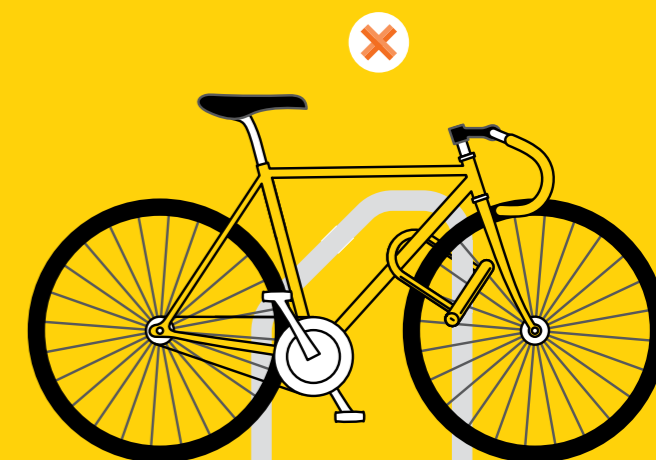

It is best to use a two-lock method,

such as a U-lock & cable lock, to maximize security when locking your bike.

When securing your bike for longer periods of time,

use the quick release function to remove the front tire, and lock it together with the frame and the back tyre to a secure fixed object such as street light or secure fence.

The latest trick of thieves

is to fill the keyhole of your Bike Lock with super glue, so you can't open it but they can come back later to steal your bike. So when locking your Bike Lock, make sure to fix it with the keyhole faced down.

Padlocks



Key padlocks

What can I do if I have lost all keys for my padlock?

If you have lost all keys for your padlock it is not possible to make key copies to unlock the padlock.

Are key copies possible?

Yes. You can generate copies of your existing key in locksmith or security shops.

Is there a possibility to get an additional new padlock that works with my already existing key?

No. If you want to operate more padlocks with a single key, please purchase multiple pack „Keyed Alike“ padlocks.

Is there an option to have padlocks that are operable with a single key?

Yes. Please purchase multiple pack „Keyed Alike“ padlocks that can be locked and unlocked with a single key.

What does „Keyed Alike“ mean?

„Keyed Alike“ means that you can lock and unlock several padlocks with a single key.

Combination padlocks

Are combination padlocks safer than key padlocks?

No. For a higher security you should use a key padlock, because the lock mechanism is stronger.

TRAVELMAX™ padlocks



Which padlock should I use for traveling?

For traveling you should use a TSA (Travel Sentry Approved) padlock. If you use a padlock that is not Travel Sentry Approved, you are taking a chance that the airport security will destroy the lock during their security check.

What is the meaning of TSA?

TSA (Travel Sentry Approved) is the international standard

for Travel Security. TSA (Travel Sentry Approved) padlocks can be opened and re-locked with a special key by international security administration at every airport.

Is there a chance that „non airport security people“ can get the „general key“ for TSA locks?

No. Only airport security people have access to the general key to open and re-lock the TSA (Travel Sentry Approved) padlocks.

STANLEY SECURITY FACTBOOK

Find out more on www.safeguard-lock.com

101 Facts | Bike locks

No. 47

Every 5 minutes a bike is stolen in Europe.

<http://www.welovecycling.com/wider/2015/11/25/european-bike-stealing-championships-in-number/>

101 Facts | Padlocks

Questions to find the right padlock

No. 25

What type of body should I choose?

The purpose of the padlock body is to protect the lock system against attacks. The main body types are Solid Brass, Laminated Steel, and Armored Encased Brass.

Solid Brass: Brass is a soft metal that is easy for producers to machine, thereby giving it a lower price for customers. But these padlocks are susceptible to drill attacks and usually have sharp corners which can scratch surfaces and objects they touch.

Laminated Steel: The body of this type is designed from separate thin steel plates which are riveted together. Low production costs enable low prices for the customers.

Armored Encased Brass: The brass body is encased in hardened steel for better protection against drilling attacks, thereby giving it a higher security level.

<http://www.safeguard-lock.com/en/service.aspx>

101 Facts | Bike locks

The number of cars and Bikes in Germany

No. 60

45,1 MLN

72 MLN

[http://www.vf.de/pressenpressemittelungen/detailnews/fahrradwirtschaft-auf-der-arbeitslosenzurück_news_p111000001news&news_p111000001detailnews&news_p111000001detailnews&news_p111000001detailnews](http://www.vf.de/pressenpressemittelungen/detailnews/fahrradwirtschaft-auf-der-arbeitslosenzurück_news_p111000001news&news_p111000001detailnews&news_p111000001detailnews&news_p111000001detailnews&news_p111000001detailnews)

101 Facts | Bike locks

Security tips

No. 68

When securing your bike for longer periods of time, use the quick release function to remove the front tire and lock it together with the frame and the back tire, securing both to a fixed object such as street light or secure fence.

<http://www.safeguard-lock.com/en/security-moments/Bike%20locks.aspx>

101 Facts | Fun facts

Love locks

No. 6

Love Locks symbolize everlasting love and are attached to bridges, fences, gates, etc. The key is thrown into the river as a romantic gesture.

<http://www.historykeys.com/padlocks-history/history-of-love-padlocks/>

101 Facts | Bike locks

No. 49

DID YOU KNOW...

Your Insurance will not pay for your loss if you did not secure your bike, home, or fence with a lock, or if the lock was too weak for the value of the possessions.

For example: A bike lock should cost about 10% of the value of your bike

So if your bike is about \$1 000, the lock should be around \$100

<http://die-hausratversicherung.eu/debtabl-rauf/>
<http://www.fahrradchloe-tests.com/>

HIGH SALES IN EVERY SEASON

Our recommendation: stanley calendar 2018.
For covering all sales opportunities.

START INTO THE YEAR



JANUARY - MARCH

- CW 01 New Years Resolutions at the Gym
- CW 02 _____
- CW 03 _____
- CW 04 _____
- CW 05 _____
- CW 06 Valentines Day
- CW 07 _____
- CW 08 _____
- CW 09 _____
- CW 10 _____
- CW 11 _____
- CW 12 _____
- CW 13 _____
- CW 14 _____

BIKE & BOAT SEASON



APRIL - JUNE

- CW 15 Bike Season Start
- CW 16 _____
- CW 17 _____
- CW 18 _____
- CW 19 _____
- CW 20 _____
- CW 21 _____
- CW 22 _____
- CW 23 _____
- CW 24 _____
- CW 25 _____
- CW 26 Boat Season
- CW 27 _____

FOR TRAVELLING AND OUTDOOR



JULY - SEPTEMBER

- CW 28 _____
- CW 29 _____
- CW 30 _____
- CW 31 _____
- CW 32 _____
- CW 33 _____
- CW 34 Holiday & Outdoor Season
- CW 35 _____
- CW 36 _____
- CW 37 _____
- CW 38 _____
- CW 39 _____
- CW 40 _____

MAKE SURE YOUR VALUABLES ARE WINTERPROOF



OCTOBER - DECEMBER

- CW 41 Standard Padlocks
- CW 42 _____
- CW 43 _____
- CW 44 _____
- CW 45 _____
- CW 46 _____
- CW 47 _____
- CW 48 _____
- CW 49 _____
- CW 50 _____
- CW 51 _____
- CW 52 _____